

KRÁTKY

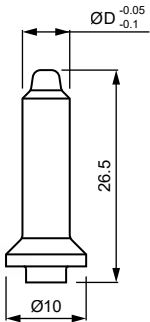

DLHÝ

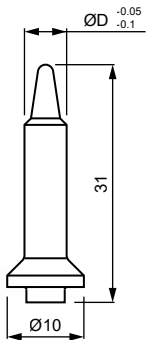

S GOLIEROM

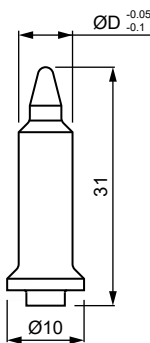

VÝMENNÉ ELEKTRODY

OTVOR V PLECHU ØD	SW 30
4.5	1111-ZK-20000
4.6	1111-ZK-20001
4.7	1111-ZK-20002
4.8	1111-ZK-20003
4.9	1111-ZK-20004
5.0	1111-ZK-20005
5.1	1111-ZK-20006
5.2	1111-ZK-20007
5.3	1111-ZK-20008
5.4	1111-ZK-20009
5.5	1111-ZK-20010
5.6	1111-ZK-20011
5.7	1111-ZK-20012
5.8	1111-ZK-20013
5.9	1111-ZK-20014
6.0	1111-ZK-20015
6.1	1111-ZK-20016
6.2	1111-ZK-20017
6.3	1111-ZK-20018
6.4	1111-ZK-20019
6.5	1111-ZK-20020

KERAMICKÉ KOLÍKY CERAZUR

OTVOR V PLECHU ØD	KRÁTKY	DLHÝ	S GOLIEROM
4.5	8228-ZK-11000	8228-ZK-10000	8228-ZK-10300
4.6	8228-ZK-11001	8228-ZK-10001	8228-ZK-10301
4.7	8228-ZK-11002	8228-ZK-10002	8228-ZK-10302
4.8	8228-ZK-11003	8228-ZK-10003	8228-ZK-10303
4.9	8228-ZK-11004	8228-ZK-10004	8228-ZK-10304
5.0	8228-ZK-11005	8228-ZK-10005	8228-ZK-10305
5.1	8228-ZK-11006	8228-ZK-10006	8228-ZK-10306
5.2	8228-ZK-11007	8228-ZK-10007	8228-ZK-10307
5.3	8228-ZK-11008	8228-ZK-10008	8228-ZK-10308
5.4	8228-ZK-11009	8228-ZK-10009	8228-ZK-10309
5.5	8228-ZK-11010	8228-ZK-10010	8228-ZK-10310
5.6	8228-ZK-11011	8228-ZK-10011	8228-ZK-10311
5.7	8228-ZK-11012	8228-ZK-10012	8228-ZK-10312
5.8	8228-ZK-11013	8228-ZK-10013	8228-ZK-10313
5.9	8228-ZK-11014	8228-ZK-10014	8228-ZK-10314
6.0	8228-ZK-11015	8228-ZK-10015	8228-ZK-10315



Na objednávku dodávame aj kolíky z materiálu Volcera.
Kód produktu: „8440-ZK-xxxx“ („xxxx“ je posledné pätčísle v tabuľke, napr. pre Ø4.5 je kód 8440-ZK-11000)

ZOSTAVY PRE NAVAROVANIE MATÍC M4 CHLADENÉ VODOU

DRŽIAKY ELEKTRÓD

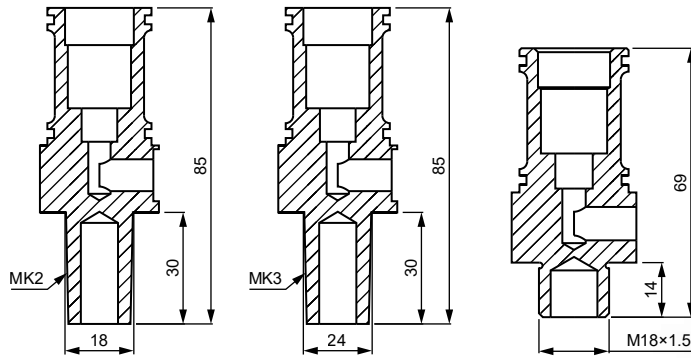

VEĽKOŠŤ MATICE	KUŽEL MK2	KUŽEL MK3	ZÁVIT M18x1.5
M4	1111-ZK-20542	1111-ZK-20543	1111-ZK-20562

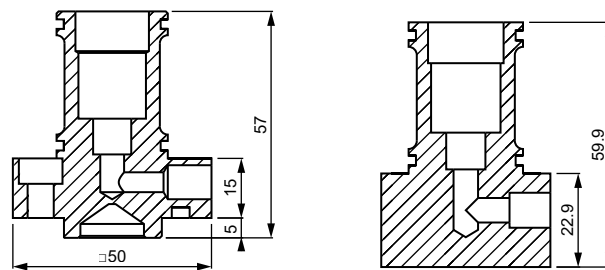

VEĽKOŠŤ MATICE	R-TYP	C-TYP
M4	1111-ZK-20642	1111-ZK-20662

CHLADIACI KRÚŽOK

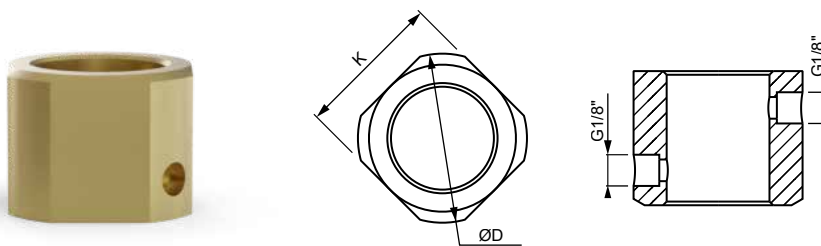

VEĽKOŠŤ MATICE	OZNAČENIE	ØD	K
M4 až M8	1113-ZK-19766	46	40
C-typ M4 až M8	1113-ZK-19766	46	40

PRÍSLUŠENSTVO K DRŽIAKOM ELEKTRÓD

PRUŽINA



DĹŽKA DRŽIAKA	OZNAČENIE
do 30 mm	1112-ZK-12205
od 40 mm	1112-ZK-12204

O-KRÚŽOK



TYP DRŽIAKA	OZNAČENIE
Ø28	1123-ZK-16436

RÝCHLOSPOJKA



—	OZNAČENIE
prívod stlačeného vzduchu G1/8"-Ø6	1116-ZK-12353

ADVANCED CERAMIC SOLUTIONS
DOCERAM[®]

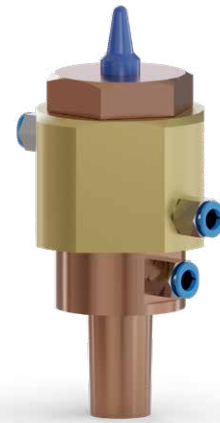

VÝMENNÁ
ELEKTRÓDA

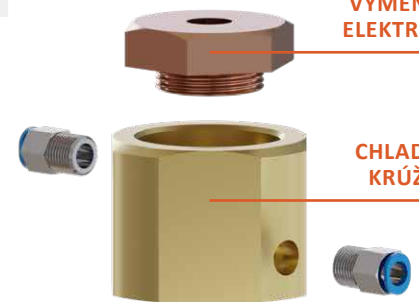

CHLADIACI
KRÚŽOK

POLOHOVACÍ
KOLÍK



PRUŽINA



DRŽIAK
ELEKTRÓDY S
O-KRÚŽKAMI



RÝCHLOSPOJKA
NA STLAČENÝ
VZDUCH

